

Homeowners' Guide for Flood, Debris, and Erosion Control after Fires



TABLE OF CONTENTS

FLOOD WATER, DEBRIS FLOWS & EROSION	3
-------------------------------------	-------------------

EMERGENCY

Do It Yourself Flood Water & Debris Control Aids	6
General Rules	7
Sandbags	8
Wooden Deflectors	12
Window And Door Protection	14
Sealing Foundations	16
General Comments	19

LONG RANGE

Erosion And Fire Control In Newly Developed Area	20
Erosion Control In Burned Areas	22
California Native Plants for Erosion Control/Slope Stabilization	23
Measures for Protecting Slopes and Surfaces from Erosion	24
Landscape Burned/Unburned Areas & Reduce Fire Hazard	26
Contact Information	28
Acknowledgements	29



FLOOD WATERS

The most common drainage problem in a community is flood waters. This occurrence is the mere passage of storm waters across areas that would normally not be affected in small storms. Remember that flood waters:

CONSIST of large quantities of water, often very turbulent and murky due to fine sediment and other soil.

OCCUR in moderate to large storms and can reach depths over the head of an individual.

INUNDATE large areas and impact any structures in their path.

DO NOT refer to ponding or localized drainage around buildings during small to moderate storms.

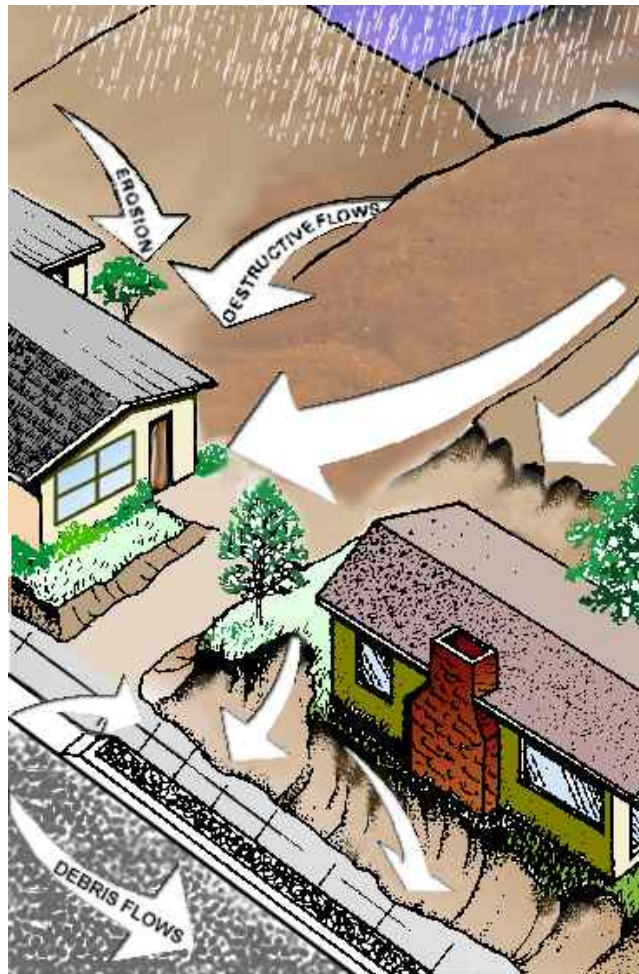

DEBRIS FLOWS

Another equally dangerous problem, usually in hillside or mountainous areas is **debris flows**. Remember that debris flows:

CONSIST of large quantities of soil, rocks, boulders, trees or brush being moved by flood waters.

OCCUR when flood waters flow over hillside and natural streambed areas and are most serious in areas stripped of vegetation by recent fire or grading.

ARE highly destructive and leave large quantities of sediment and rocks in their paths when the storm subsides.

CONTAIN sufficient strength to destroy objects in their path.

CAN be controlled or directed to reduce property damage.

DO NOT UNDERESTIMATE THE POWER OF DEBRIS FLOWS

Early planning and early action can reduce possible damage during the storm season. Once the debris flows start, it is too late to plan protection.

START IMMEDIATELY!!



EROSION

A complicating problem of storm or flood waters passing over land is often **erosion**. The result of erosion is often steep banks of scoured soil or other ground material. Remember that erosion:

CANNOT be controlled while it is happening and is often not seen until the flood waters have subsided.

CAN seriously undermine structures, leading to major failures.

OCCURS most often when waters flow rapidly over loosely compacted soil or slopes stripped of vegetation.



DO IT YOURSELF FLOOD WATER & DEBRIS CONTROL AIDS

ARE not expensive when compared to the protection received.

CAN be installed with normal household tools.

CONSIST of materials readily available at your local lumber yard.

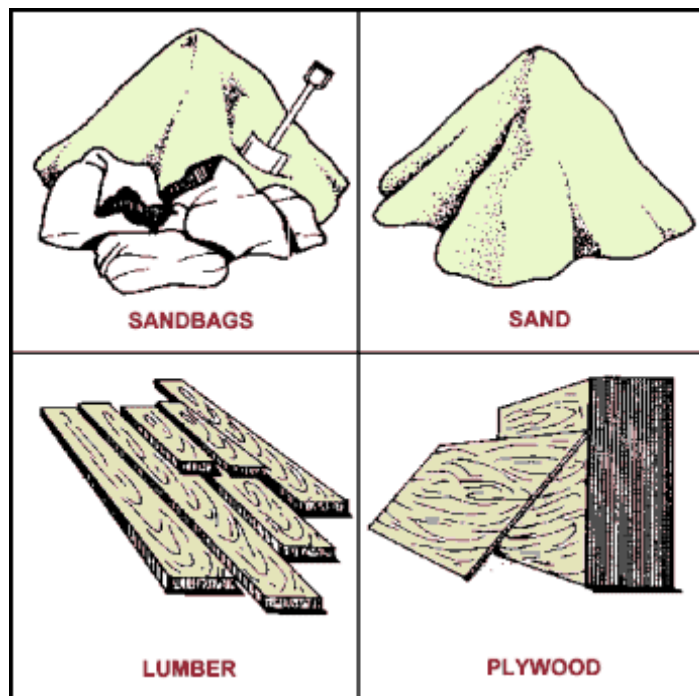

GENERAL RULES

Each situation differs; however, basic rules can be followed in all cases involving flood water & debris movement.

NEVER Underestimate the power of flood waters or debris flows.

TRY to direct flood water & debris flows away from structures & improvements.

AVOID trying to confine the flows more than is absolutely required.

CLEAR a path for the debris.

USE your house or building as a deflector if necessary.

ALWAYS place protection to **deflect** flows, not to stop them.

DEBRIS will often enter a building through windows. . . board them up!

REMEMBER to protect your most valuable property first . . . your home.

THEN consider what time and money are available to protect other less valuable objects, such as swimming pools or landscaping.

TRY to install more permanent measures to protect your home. The problem of debris flows will exist for several years after a burn. Sandbags usually last for only a year.

ALWAYS work with adjacent affected property owners.

BE prepared to sacrifice the use of portions of your property to achieve good protection.

AVOID Altering drainage patterns that could worsen conditions for your neighbor.

The following pages cover typical installations of sandbags, timber and plywood to protect buildings and grounds.



SANDBAGS

Sandbags, when properly filled and placed, will redirect storm and debris flows away from property improvements.

FILLING

1. Fill sandbags one-half full. This keeps the bag from getting too heavy, and permits the bags to be stacked with a good seal. Sand is suggested if readily available; however, sand is not mandatory, and any local soil may be used.
2. Filling sandbags is a two-person operation. Both people should be wearing gloves to protect their hands. One member of the team should place the empty bag between or slightly in front of widespread feet with arms extended. The throat of the bag is folded to form a collar, and held with the hands in a position that will enable the other team member to empty a rounded shovel full of material into the open end. The person holding the sack should be standing with knees slightly flexed, and head and face as far away from the shovel as possible. The shoveler should carefully release the rounded shovel full of soil into the bag. Haste in this operation can result in undue spillage and added work. The use of safety goggles is recommended.
3. For a more durable bag with increased effective life, mix 10 parts of sand or soil with one part of cement. The materials can be mixed and placed dry. After all bags are in place, a light sprinkling of water is recommended. This technique is only effective with burlap sandbags and will not work with plastic sandbags.



PLACING

1. Fold the top of the sandbag down and rest the bag on its folded top.
2. It is important to place bags with the folded top toward the upstream or uphill direction to prevent bags from opening when water runs by them.

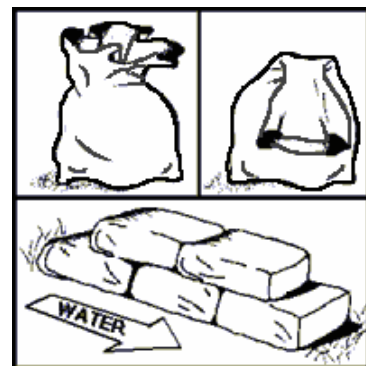

3. Care should be taken to stack sandbags in accordance with the illustrations. Place each sandbag as shown, completing each layer prior to starting the next layer. Limit placement to two layers unless a building is used as a backing or sandbags are pyramided.

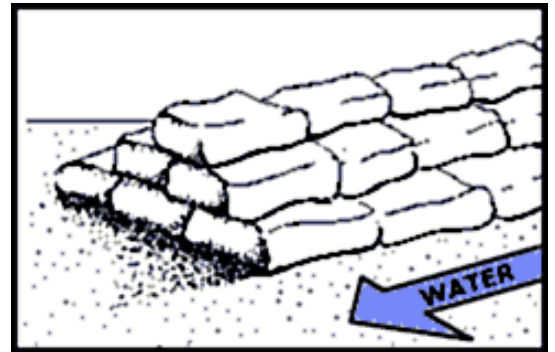

Pyramided sand bags

LIMITATIONS

1. Sandbags will not seal out water.
2. Sandbags deteriorate when exposed for several months to continued wetting and drying.
3. Sandbags are basically for low-flow protection (up to two feet). Protection from higher flows requires a more permanent type of structure.

PROTECTING BUILDINGS WITH SANDBAGS



Sandbag stacking against building

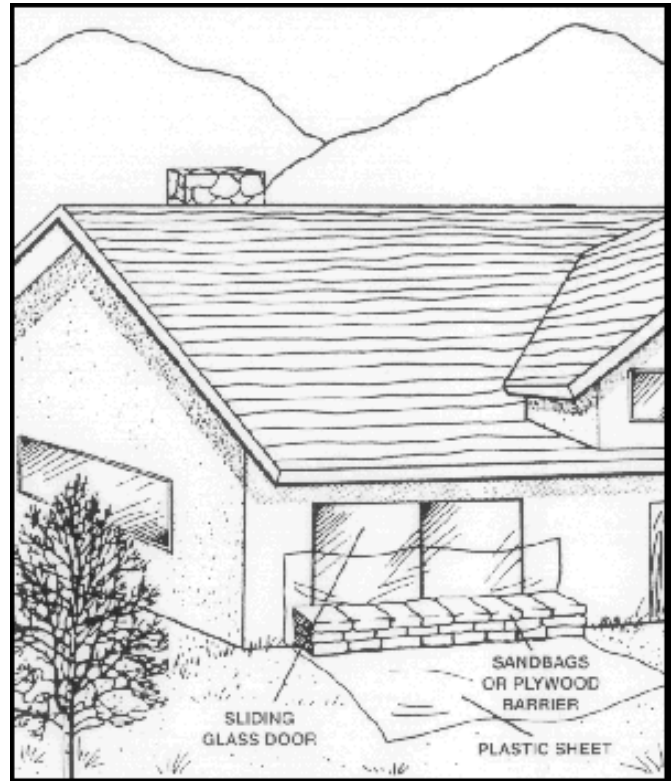

Sliding Glass Door Sealing

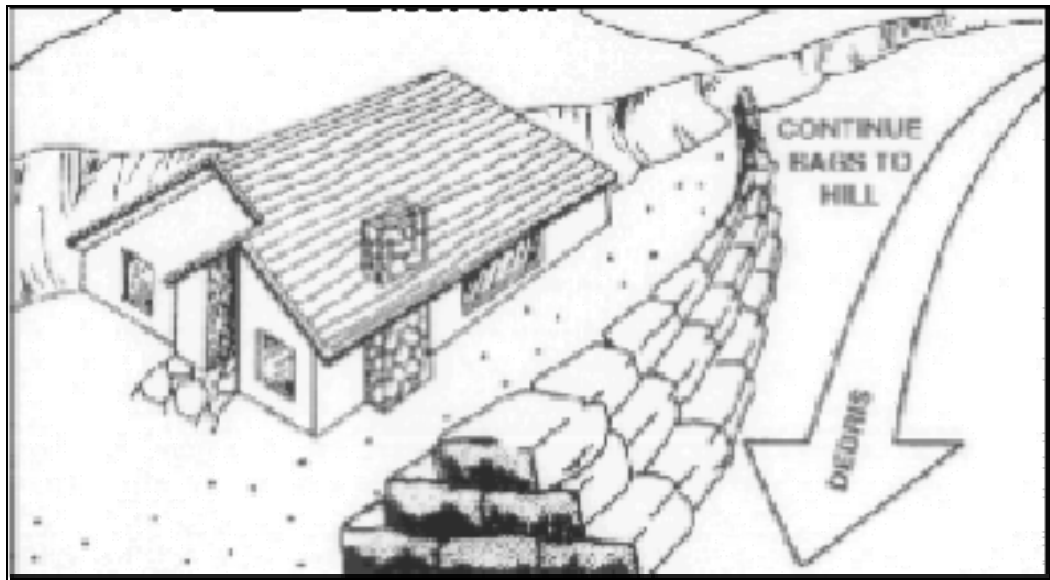

Directing Debris Away From Buildings



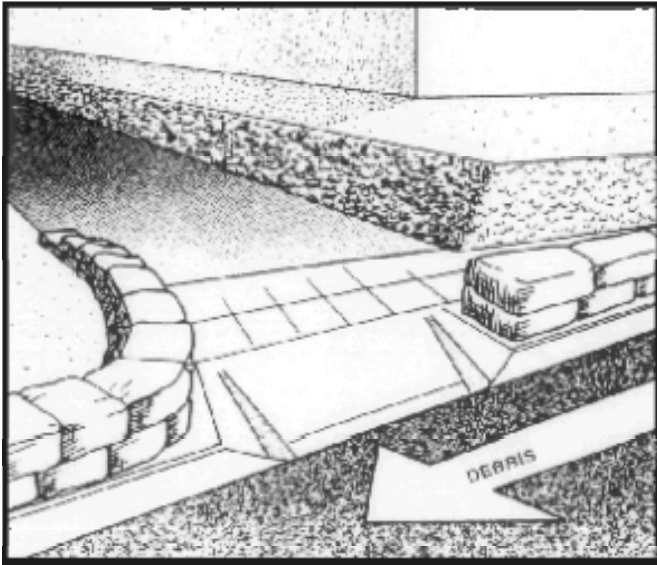

**Controlling Debris or Storm Flows
in Streets**

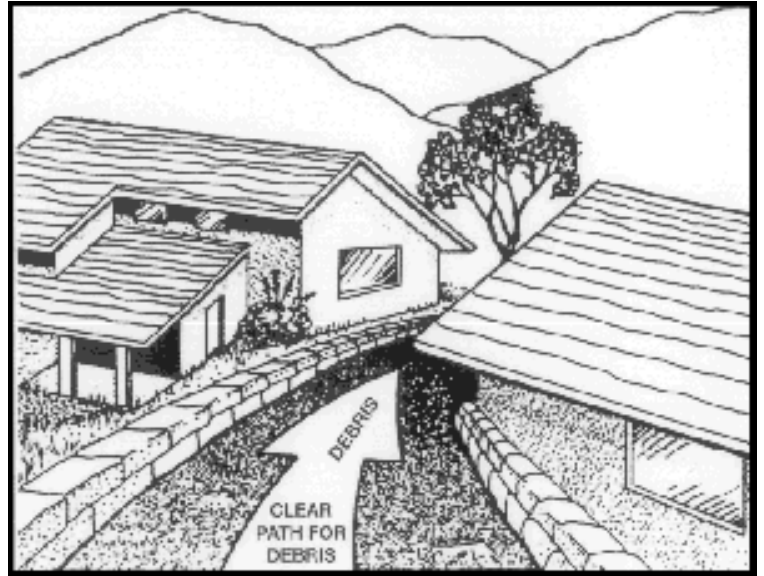

Directing Flows Between Buildings

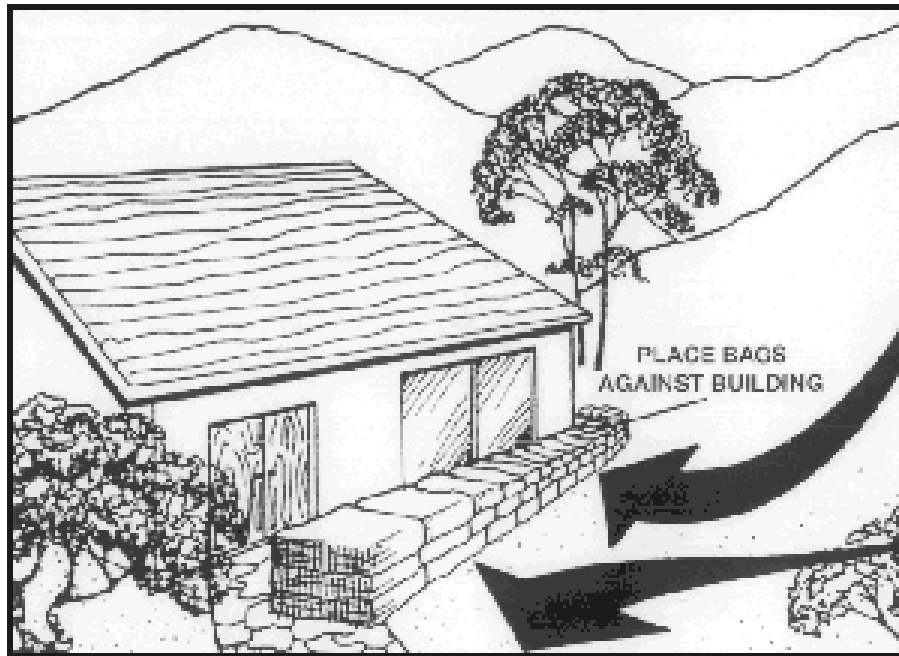

WOODEN DEFLECTORS

USE low-grade lumber and overlap section with protruding end facing downstream.

DRIVE stakes to at least one-half their length to ensure proper anchorage.

PLACE deflectors on solid, level soil if possible to reduce the hazard of undercutting.

DO NOT attempt to use the lumber as a dam.

SOIL firmly packed behind the deflector will provide needed additional strength.

PLACE sandbags against the house if debris deflector required is greater than three feet.

IF deflector required is more than three feet in height, house will have to be protected with sandbags and used as a deflector.

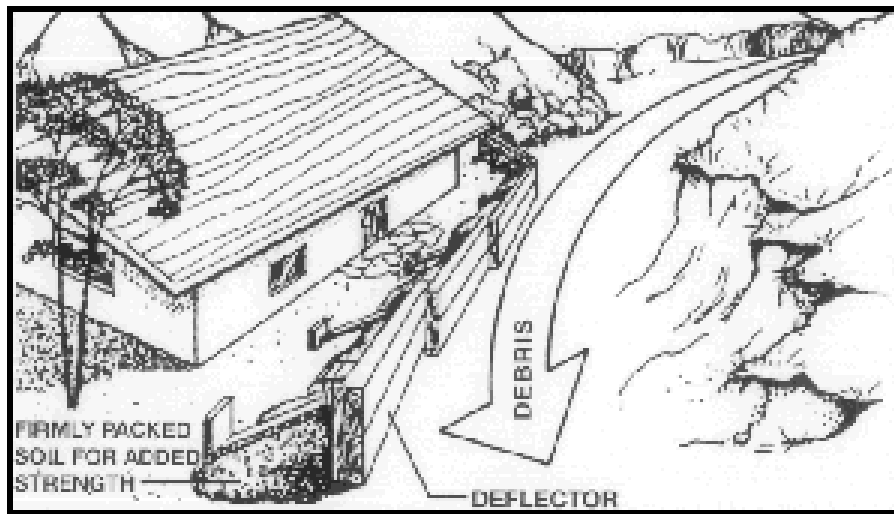

Timber Deflector

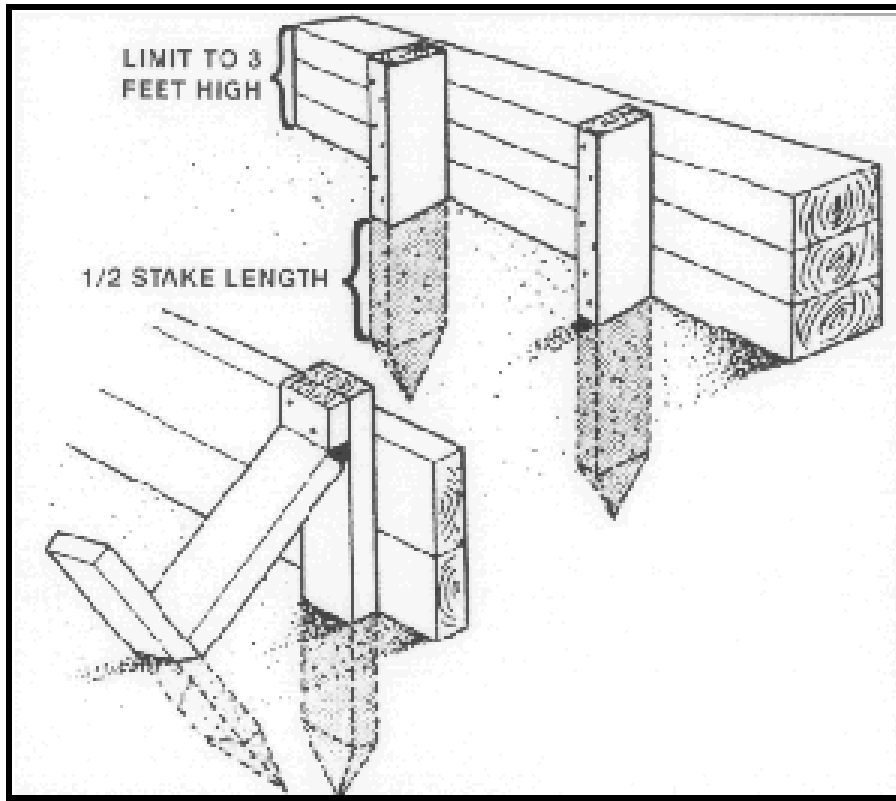

Timber Deflector Detail

WINDOW AND DOOR PROTECTION

PROVIDE protection against debris entering around doorways and windows by use of boards or plywood.

COVER doors and windows completely with plywood, if affected by the hazard, and use an alternate entrance.

USE low-grade plywood to overlap windows, vents and doors 3 to 4 inches on all sides.

SECURE each sheet of plywood with four or more nails, screws or bolts; stakes and boards may also be used to wedge barriers in place. As an alternative, standing pipes on both sides of a door may be used to secure a removable barrier.

MATERIALS can be dismantled after the storm season and stored year-to-year.



SEALING DOORS

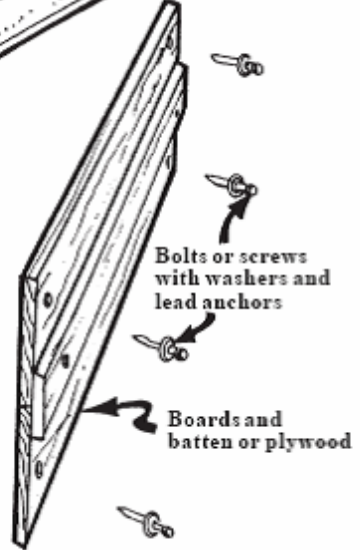
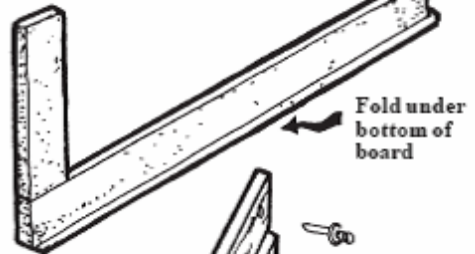
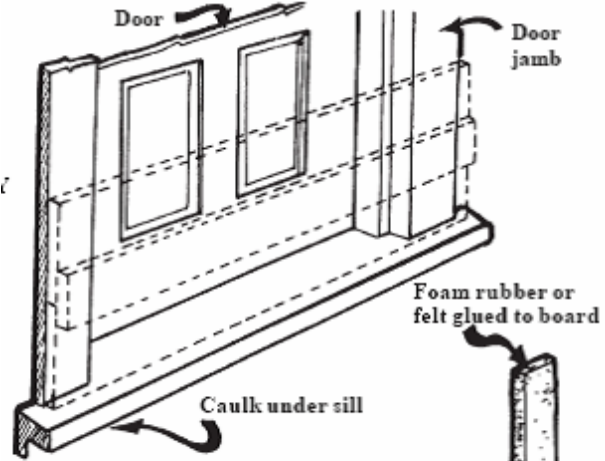
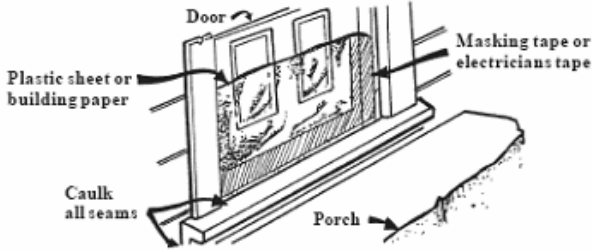
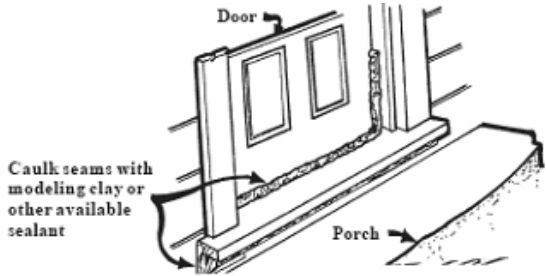
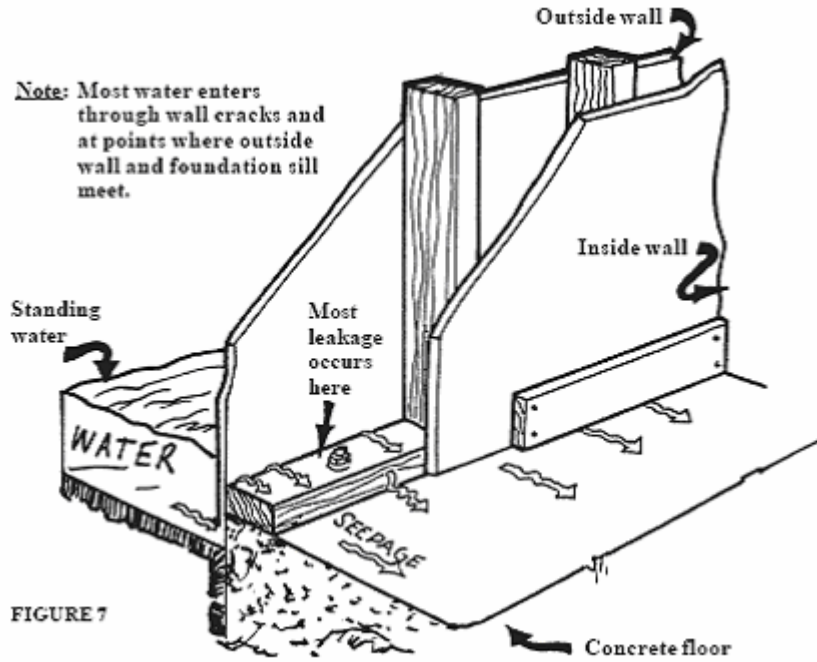

FIGURE 17



SEALING FOUNDATIONS (Typical Paths of Entry)



CONCRETE SLAB FLOOR

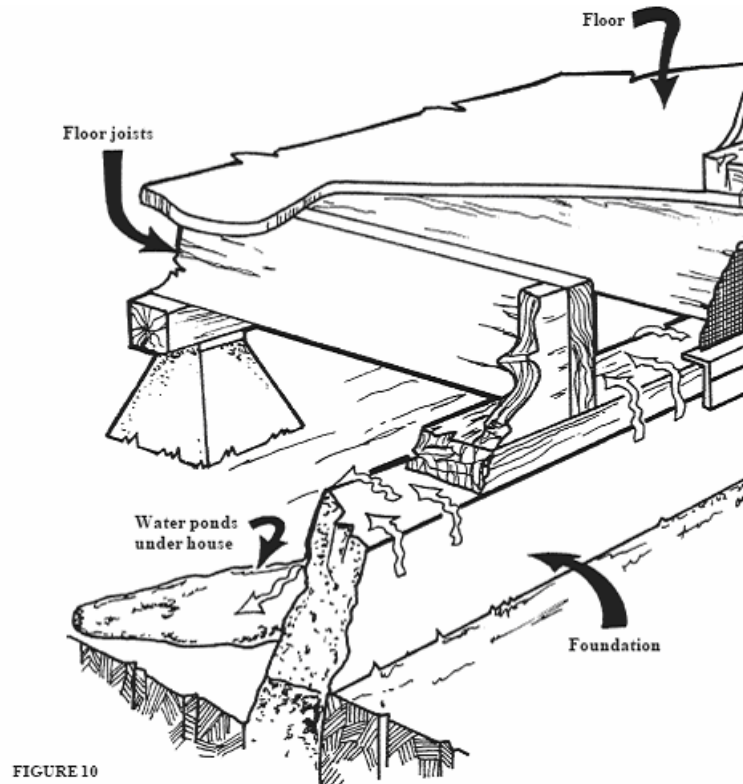

WOOD FLOOR



PREPARATION OF STUCCO SIDING

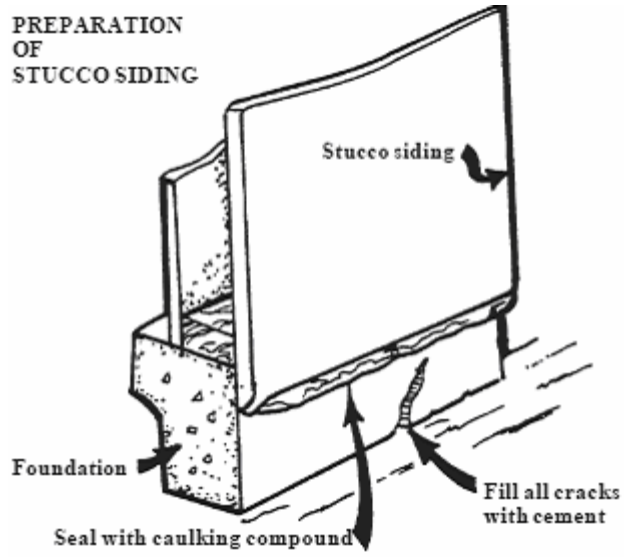

SEALING FOUNDATIONS & STUCCO SIDING

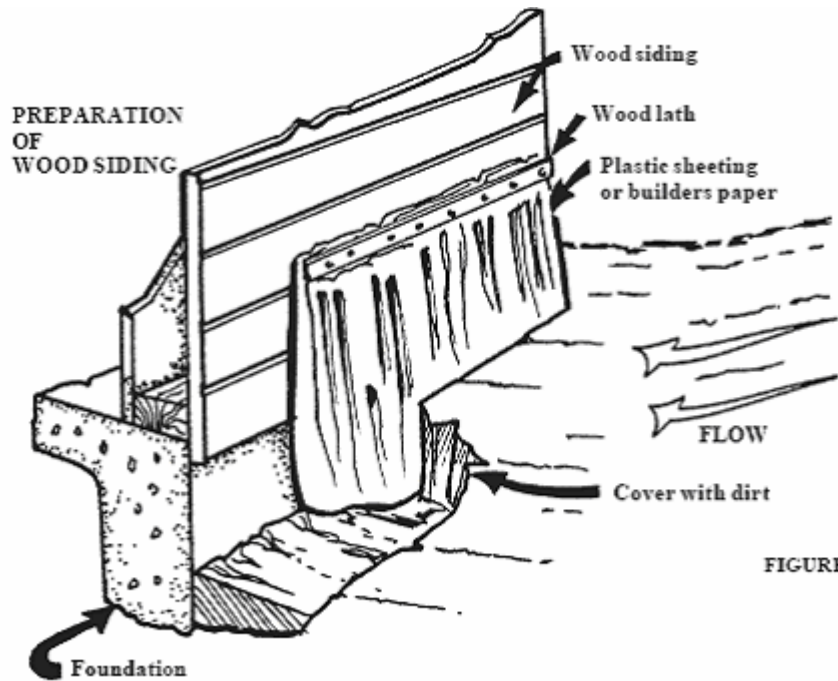
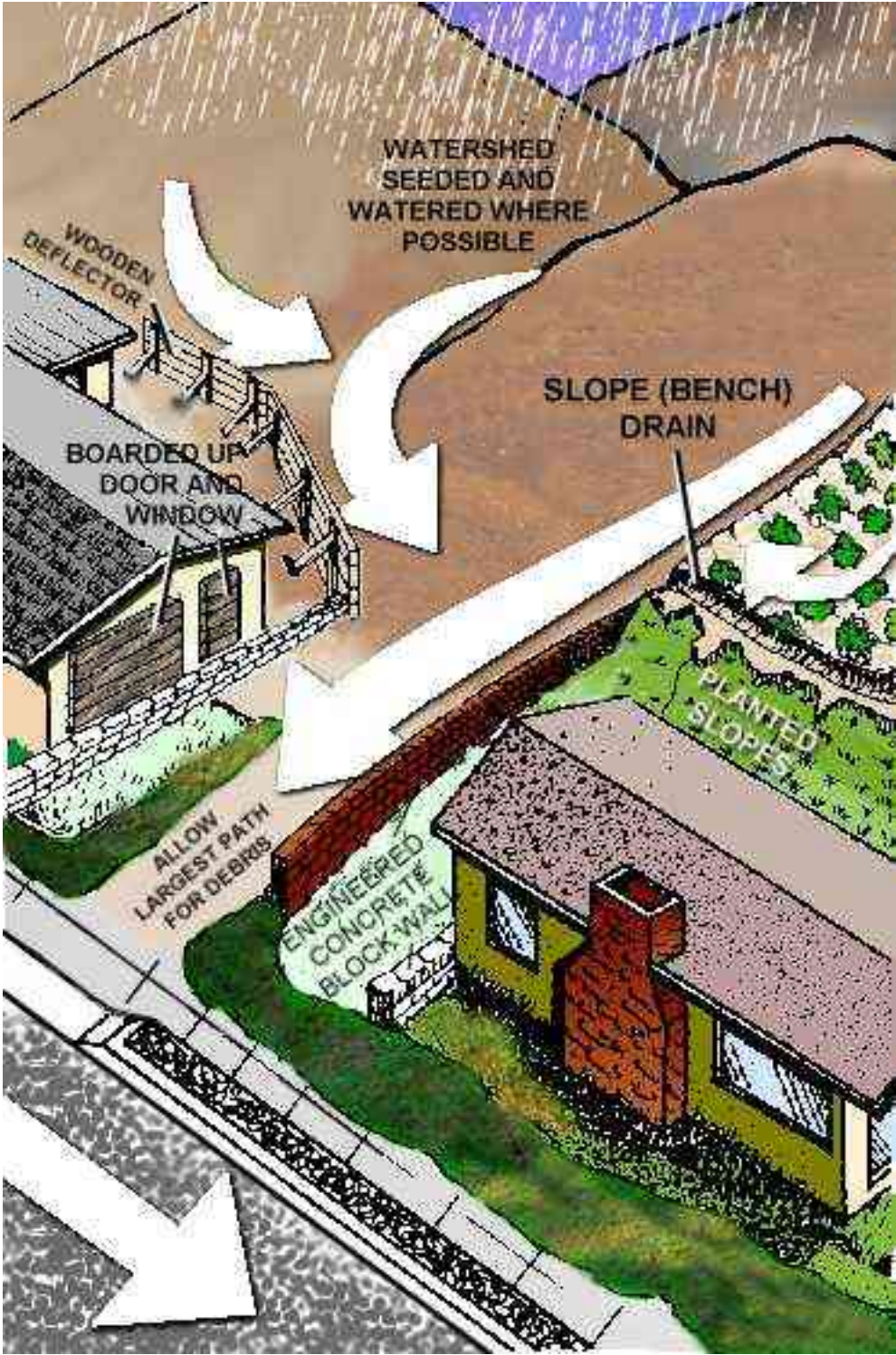

FIGURE 9

SEALING FOUNDATIONS & WOOD SIDING



HOMES PROTECTED FROM MAJOR DAMAGE



GENERAL COMMENTS

DO NOT underestimate the power of debris or flood water flows.

DO NOT wait until the storm season to start your planning and installation of flood, debris, and erosion control facilities. Start as soon as possible. Once debris and flood water flows begin, it is usually too late to install protection.

PROTECTION is not always pleasing to the eye and appearance should not dictate location or type of installation.

BE prepared to personally observe and maintain your installations during storm periods, for in many cases a minor correction will prevent major failure. However, **do not** take any unnecessary risks.

SHOULD your flood, debris, and erosion control problems appear to warrant facilities in excess of the measures described in this document, it is recommended that you consult a competent expert for additional advice.



EROSION AND FIRE CONTROL IN NEWLY DEVELOPED AREAS

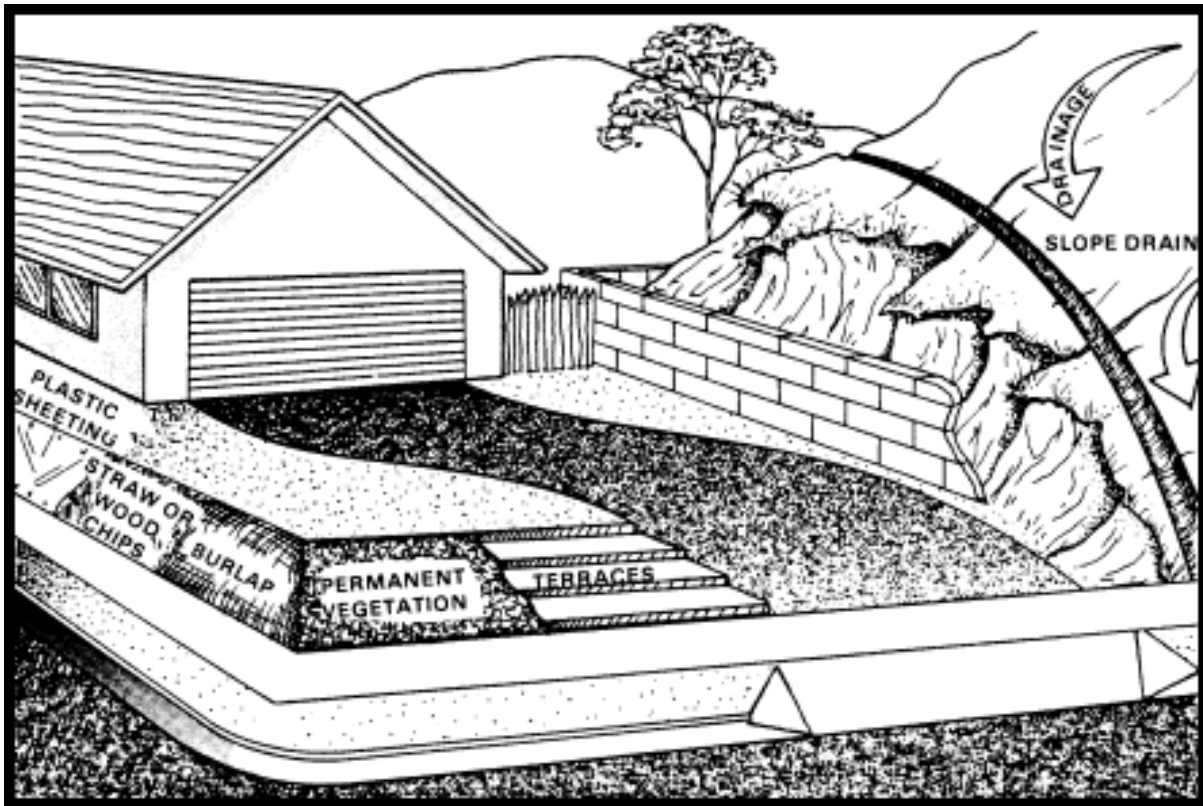

CONTROL WATER FLOWING INTO PROPERTY Dig a small ditch with a hoe or shovel fairly close to the upper edge of the property. Build the ditch nearly on the horizontal to ensure slow water movement. Provide for the ditch to drain into a natural watercourse or onto street pavement or to a well vegetated area.

CONTROL RUNOFF ON SLOPES Dig the same type of small ditch at the top of each steep slope. Do not allow large amounts of water to concentrate along one route. On soils especially susceptible to erosion, additional protection can be gained by using inexpensive plastic sheeting. These sheets should be overlapped like shingles and securely tied or weighted down so that the majority of water does not reach the soil. Shrubs may be planted through the plastic by cutting a hole just large enough for growth. Where ditches are used in unstable soil, the ditch should be sowed with perennial grasses. **NOTE:** Plastic sheeting should not be used as a permanent solution as it retards vegetation establishment.



***STRENGTHEN
THE SOIL TO
RESIST
EROSION*** Straw or wood chips are effective in holding the soil in place. They have the added value of increasing the organic content of the soil. Place a covering of chips 1 inch (or less) as slope and soil conditions indicate.

Woven burlap can be laid on the slope and tied down with stakes to prevent lifting by wind or water. Regular planting procedures can be followed before laying the burlap since it will not interfere with establishing growth on the slope. The burlap will decompose eventually, but will remain long enough for vegetation to become well established.



EROSION CONTROL IN BURNED AREAS

One of the most appropriate erosion and sediment control measures (called Best Management Practices [BMPs]) following a wildfire is preservation of existing vegetation. Whether burned or unburned, the roots of vegetation hold the soil together. Tree removal in the fall and winter following a fire will disturb soil at a time of the year when it is most vulnerable to erosion. Unless trees or shrubs pose an imminent health/safety hazard, it is recommended that they be left in place.

PLANTING is similar to planting in newly developed areas.

STRESS rapid growth ground covers.

PLANT throughout burned area.

WATERING may be necessary to assure early growth.

REMEMBER the rainy season runs from October thru April so plant now!



California Native Plants
Recommended for Erosion Control / Slope Stabilization
(Cross-referenced to Orange County Fire Authority Fuel Modification Zone Plant List July 9, 2004)

Code	Taxonomic Name	Common Name	Plant Form
W	<i>Arctostaphylos edmundsii</i>	Little Sur Manzanita	Ground Cover
o	<i>Arctostaphylos edmundsii</i> 'Carmel Sur'	Little Sur Manzanita Selection	Shrub
W	<i>Arctostaphylos uva-ursi</i> 'Point Reyes'	Bearberry	Ground Cover
X	<i>Atriplex lentiformis</i> ssp. <i>brewerii</i>	Brewers Salt bush	Shrub
W	<i>Baccharis pilularis</i>	Coyote Brush / Chaparral Broom	Shrub
o	<i>Baccharis pilularis</i> 'Pigeon Point'	Dwarf Coyote Brush	Ground Cover
W	<i>Ceanothus griseus</i> horiz. 'Yankee Point'	Wild Lilac Selection	Ground Cover
W	<i>Ceanothus</i> 'Joyce Coulter'	Creeping Mountain Lilac	Ground Cover
o	<i>Ceanothus spinosus</i>	Greenbark Ceanothus	Shrub
o	<i>Heteromeles arbutifolia</i>	Toyon	Shrub
W	<i>Iva hayesiana</i>	Poverty Weed	Ground Cover
W	<i>Mahonia repens</i> (Shade Areas)	Creeping Oregon Grape	Shrub
o	<i>Rhamnus crocea</i>	Redberry	Shrub
o	<i>Rhamnus crocea ilicifolia</i>	Holly-leaf Redberry	Shrub
o	<i>Rhus integrifolia</i>	Lemonade Berry	Shrub
o n	<i>Rhus ovata</i>	Sugar Bush	Shrub
W	<i>Ribes viburnifolium</i> (Shade Areas)	Evergreen Currant	Shrub
o	<i>Symphoricarpos mollis</i>	Southern California Snowberry	Shrub

(see Orange County Fire Authority Fuel Modification Plans and Maintenance Program for details on fuel modification zones and requirements.)

http://www.firepreventionofficers.org/resources/orco_fuelmod_guide.pdf

Legend:

X = Plant species prohibited in wet and dry fuel modification zones adjacent to reserve lands. Acceptable on all other fuel modification locations and zones.

W = Plant species appropriate for use in wet fuel modification zones adjacent to reserve lands. Acceptable in all other wet and irrigated dry (manufactured slopes) fuel modification locations & zones.

o = Plant species native to Orange County. Acceptable in all fuel modification wet and dry zones in all locations.

n = Plant species acceptable on a limited use basis. Refer to qualification requirements following plant palette in OCFA Fuel Modification Plans & Maintenance Guide.

NOTE: For more information on drought-resistant and/or fire resistant ground covers, shrubs, trees and grasses, contact your local nursery.



Measures for Protecting Slopes and Surfaces from Erosion

The focus of your erosion control strategy should be on permanently stabilizing all slopes and exposed surfaces. Proper planting of slopes is usually the easiest way to prevent erosion. Barren areas should be replanted as soon as possible and temporary measures used until the plants are well established. Professionally applied slope stabilization is commercially available, and should be considered on high, steep slopes. These and other temporary measures are discussed below.

Fiber Rolls. Fiber rolls consist of straw, flax, or other similar materials bound into a tight tubular roll. When they are placed at the toe and on the face of slopes, these devices intercept runoff, reduce its flow velocity, release the runoff as sheet flow, and provide removal of sediment from the runoff. When used on the slope itself, fiber rolls can also be effective in reducing erosion. They are not effective unless trenched.

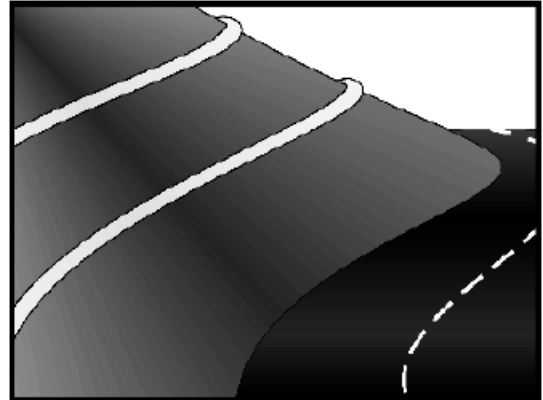

Silt Fences. Silt fences are made of a filter fabric that has been entrenched, attached to supporting poles, and sometimes backed by a plastic or wire mesh for support. They detain sediment-laden water, promoting sedimentation behind the fence. Silt fences are suitable for perimeter control and should be placed below areas where sheet flows discharge from the site. They are only applicable for sheet or overland flows, and should not be used on slopes. They are most effective when used in combination with erosion controls.

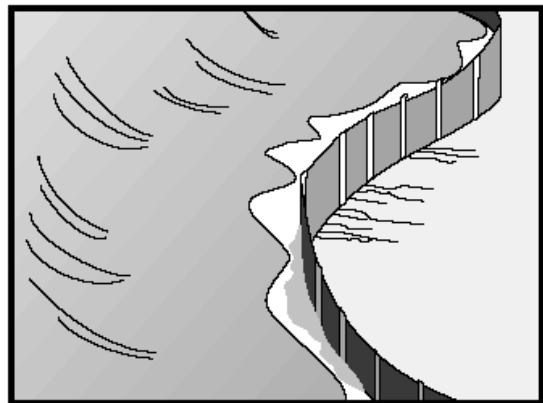

Straw Matting- Straw matting is used to cover the soil surface to reduce erosion from rainfall impact, hold soil in place, and absorb and hold moisture near the soil surface. It can also be used to stabilize soils until vegetation is established. Matting is commonly applied on short steep slopes where erosion hazard is high and vegetation will be slow to establish. This approach is particularly useful when

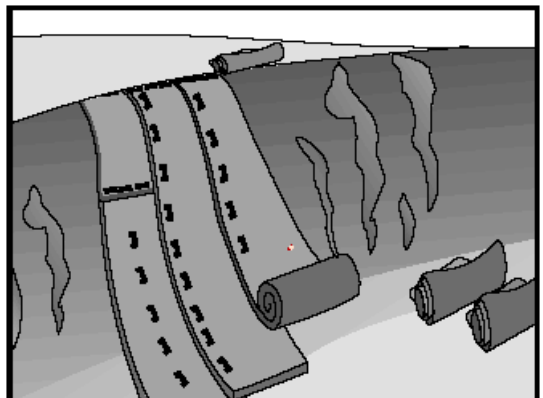

seeding cannot occur (e.g., late season, construction, or the arrival of an early rain season). Matting can be laid on vulnerable slopes and tied down with staples to prevent lifting by wind or water.

Straw or Wood Chip Mulching. Straw or wood chips can be used to hold soil in place. This has the added benefit of increasing the organic content of the soil. A cover layer of chips approximately 2 inches deep (or less) can also be used as slope and soil conditions warrant.



LANDSCAPE BURNED/UNBURNED AREAS AND REDUCE FIRE HAZARD



Uncontrolled Chaparral Growth

<i>PREVENT</i>	erosion with: Quick growing, fire retardant ground covers planted on contours, burlap mats, straw mulch, or chemicals.
<i>CONTROL</i>	regrowth of chaparral-type brush.
<i>PLANT</i>	grass or succulent ground covers surrounding all structures.
<i>PLANT</i>	only fire-retardant trees, shrubs & ground cover.
<i>PLANT</i>	screens of fire-retardant shrubs or trees where ground cover or grass ends.



HOMES PROTECTED BY CLEARING



ELIMINATE Or reduce chaparral-type plants that serve as fuel.

LEAVE Space between remaining shrubs and trees so they will not carry fire easily.

KEEP Landscape clean. Remove litter under trees and shrubs and prune out dead growth. Remove dead and dried portions of ground covers and succulents.

INCREASE Effectiveness of fire-retardant plantings with a high pressure sprinkler system.

NATIVE BRUSH Should be cleaned within 30 feet of buildings and brush limited to 18 inches in height to within 70 feet of buildings.

ONLY A limited number of specimen shrubs and trees can be allowed within 30 feet of a building.



CONTACT INFORMATION

Flood/Erosion

Orange County Storm Operations Center (714) 567-6333
RDMD Operations & Maintenance (Alternate) (714) 567-6300

Orange County Emergency Operations Center (714) 628-7054
24-Hr Emergency Dispatch (714) 628-7008

National Flood Insurance Program (888) 379-9531
<http://www.fema.gov/about/programs/nfip/index.shtm>

National Weather Service

<http://www.weather.gov/>

National Forest Information

Cleveland National Forest (878) 674-2901
<http://www.fs.fed.us/r5/cleveland/>

Orange County Fire Authority (714) 573-6000
<http://www.ocfa.org>

Orange County Sheriff (714) 647-7000
<http://www.ocsd.org/>

Disaster Assistance

Red Cross (714) 481-5300
<http://www.oc-redcross.org/>

**To report a life threatening emergency,
call 911.**



Acknowledgements

The Orange County Flood Control Division gratefully acknowledges the technical assistance of the following publications in the preparation of this document:

“Flood Fighting: How to Use Sandbags” published by U.S. Army Corps of Engineers – Emergency Management Branch.

“Fuel Modification Plans and Maintenance Guide” published by the Orange County Fire Authority.

“Homeowners’ Guide for Flood, Debris, and Erosion Control after Fires” published by Los Angeles County Department of Public Works.

“Plants for Erosion Control / Slope Stabilization” by El Nativo Growers, Inc.

“Stormwater Best Management Practice Handbook-Construction”, published by California Stormwater Quality Association.

